

Schizzo di progetto
Concept sketch

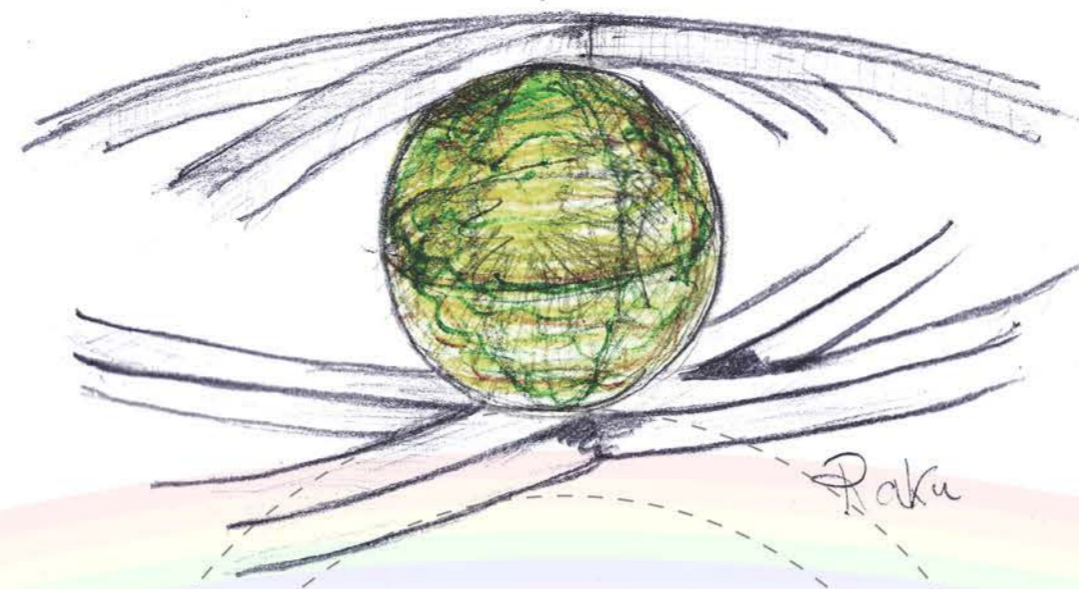

Elemento decorativo - Ceramica Raku
Raku ceramics - decorative element

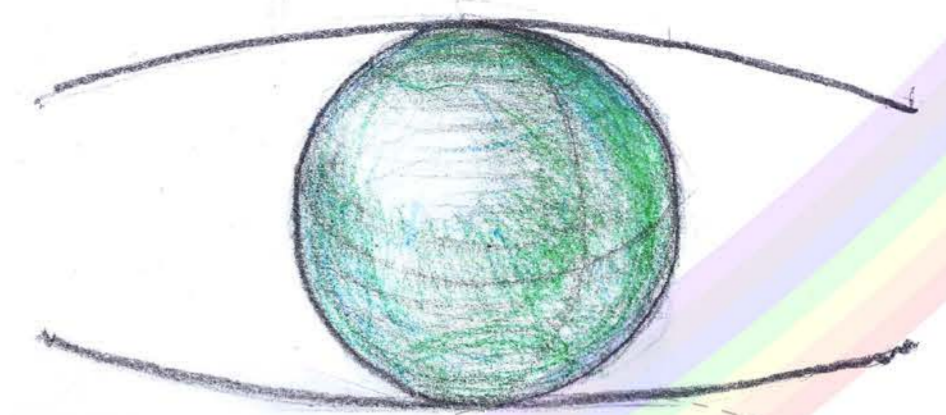

Elemento decorativo - Vetro
Glass - decorative element

Costruzione geometrica:
Geometric design:



Forma base:
Base shape

Contrapposizione archi
Opposed arcs

Elemento sferico di giunzione
Joint sphere

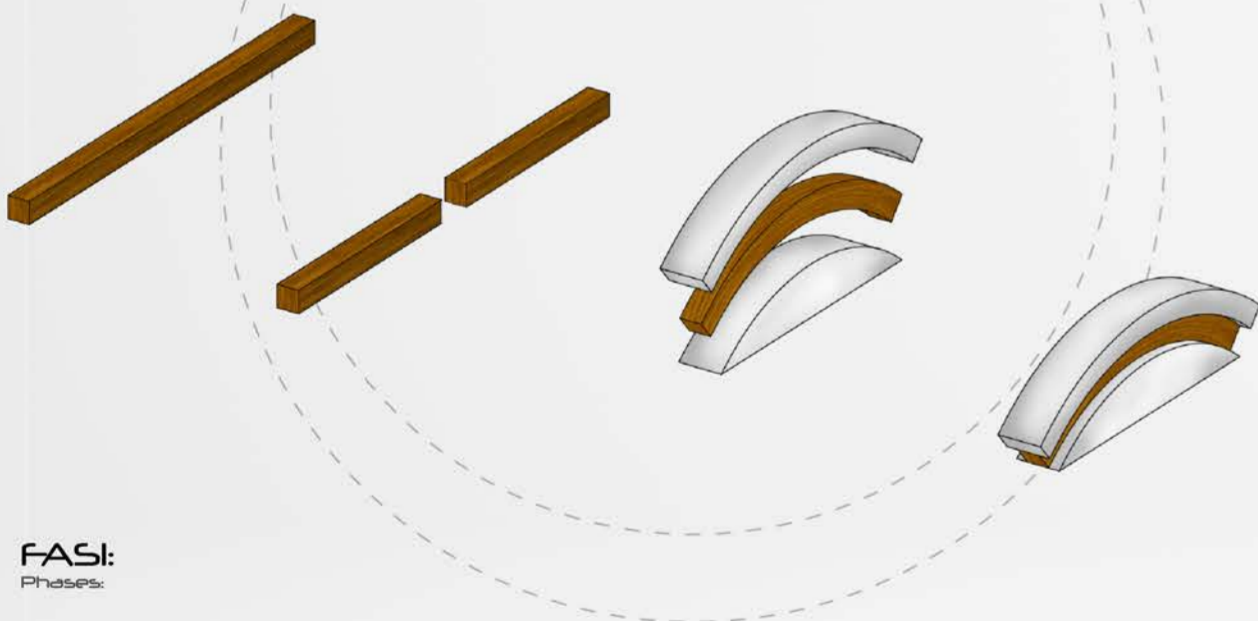

FASI:
Phases:

- Legno massello Teak - 100x100x2000mm
Teak solid wood - 100x100x2000 mm
- Diviso in due parti per la piegatura
Divided in two part for bending
- Piegatura dei due semi archi
Bending of the two halves
- Ricomposizione dell'arco post-piegatura
After Bending - Arc recomposition
- Primo step - Sagomatura profilo
First step - Shaping profile
- Secondo step - Incisione scanalature e fori di fissaggio
Second step - Affect joints and drilling

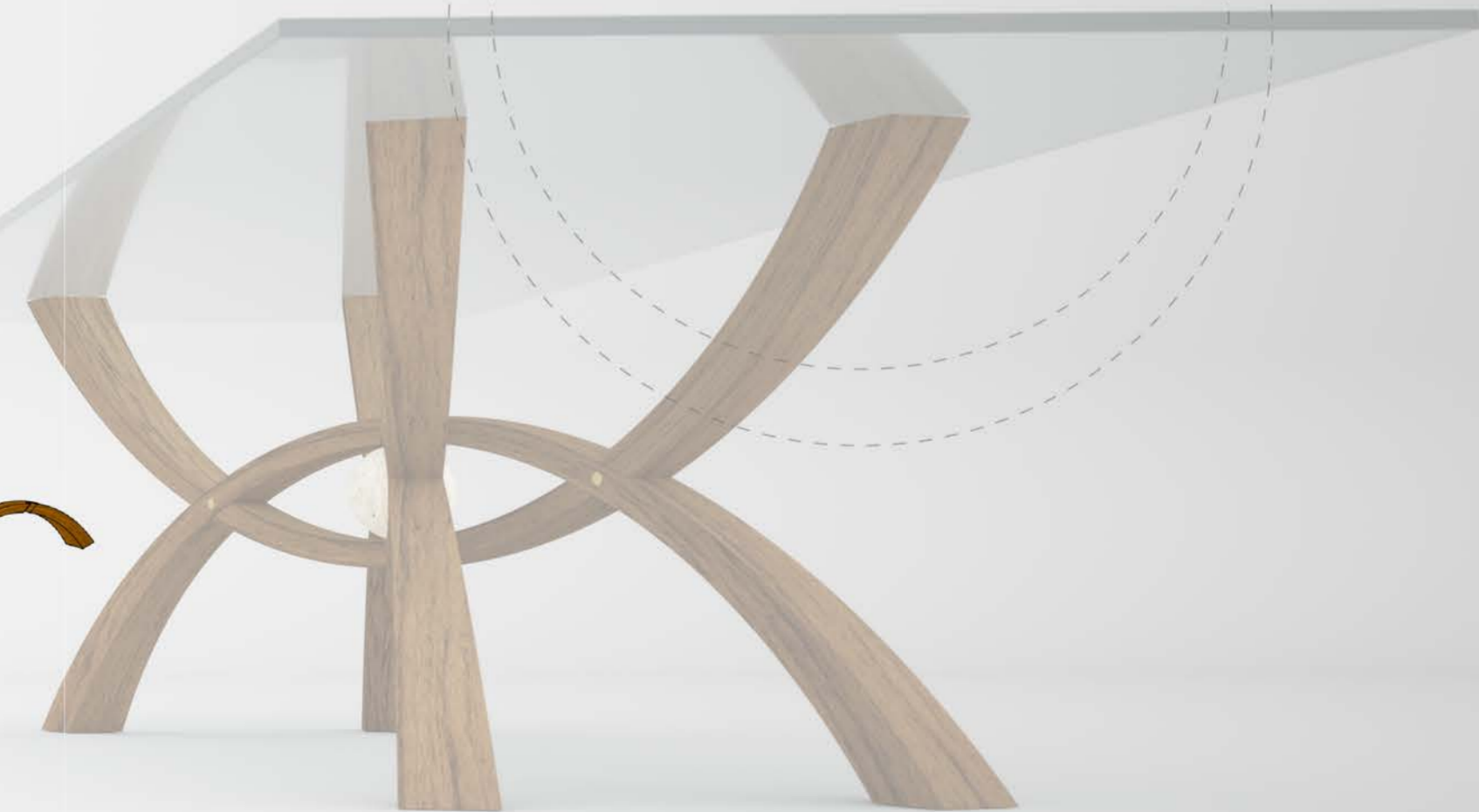

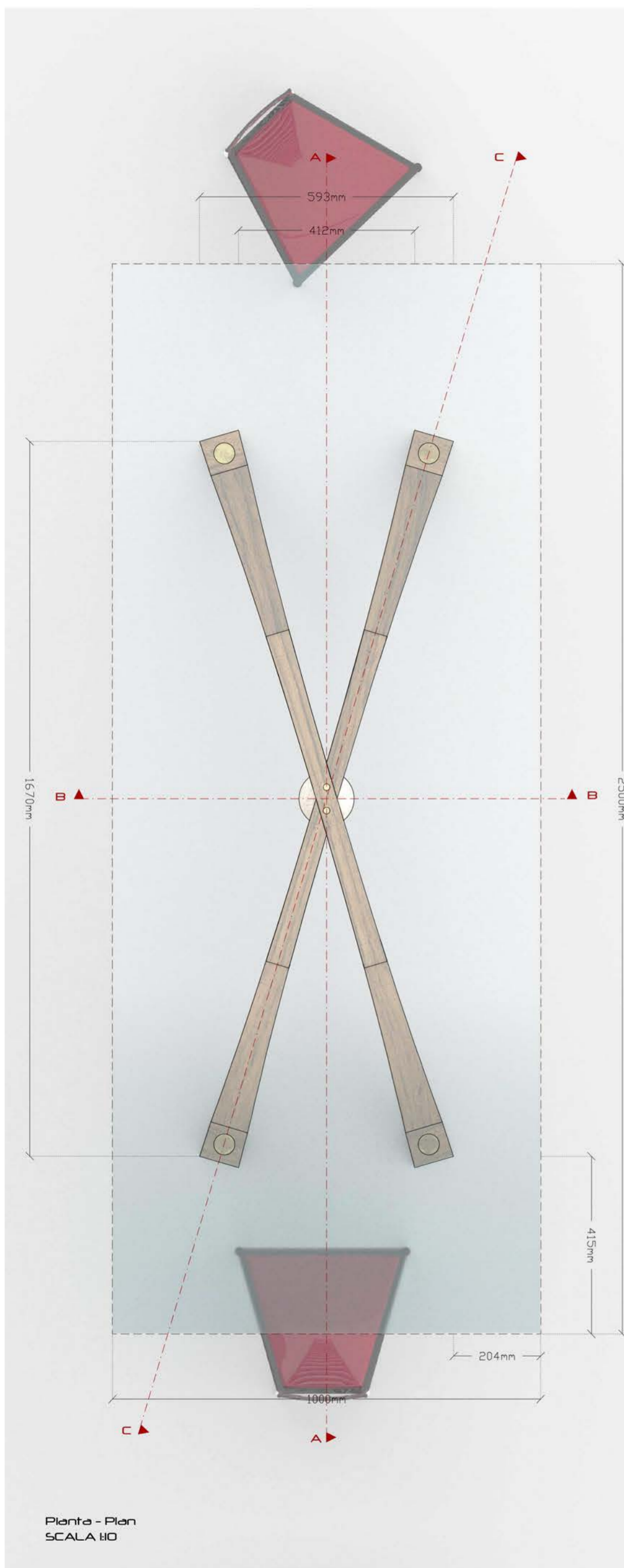

Planta - Plan
SCALA 1:10

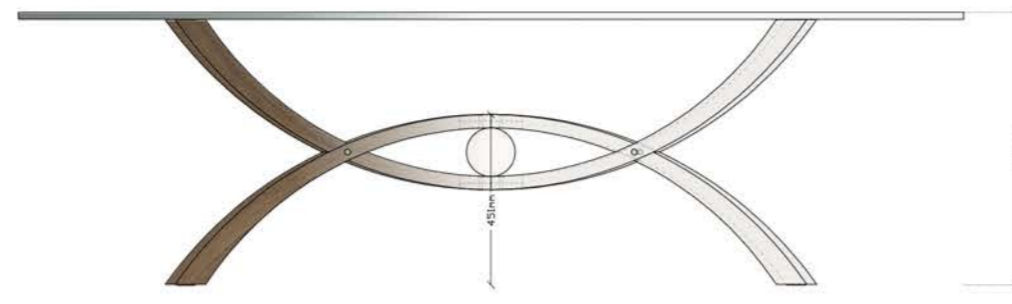

Prospetto frontale - Frontal elevation
SCALA 1:20

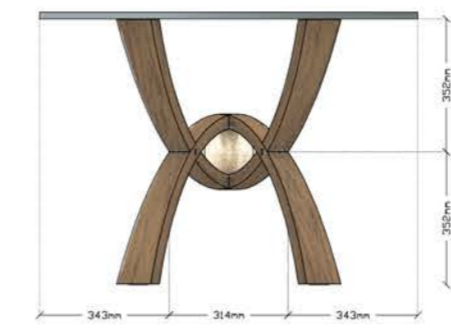

Prospetto laterale - Side elevation
SCALA 1:20

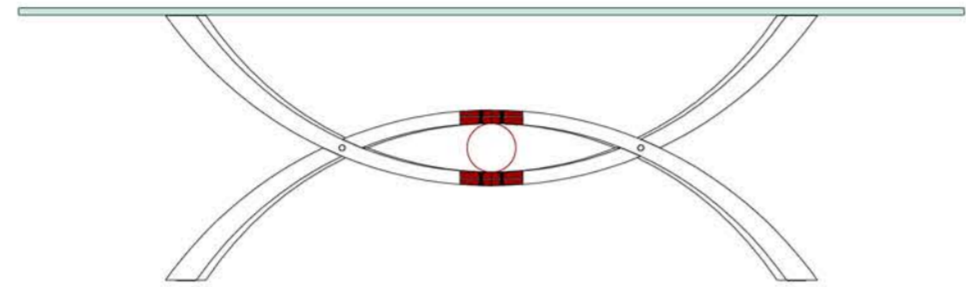
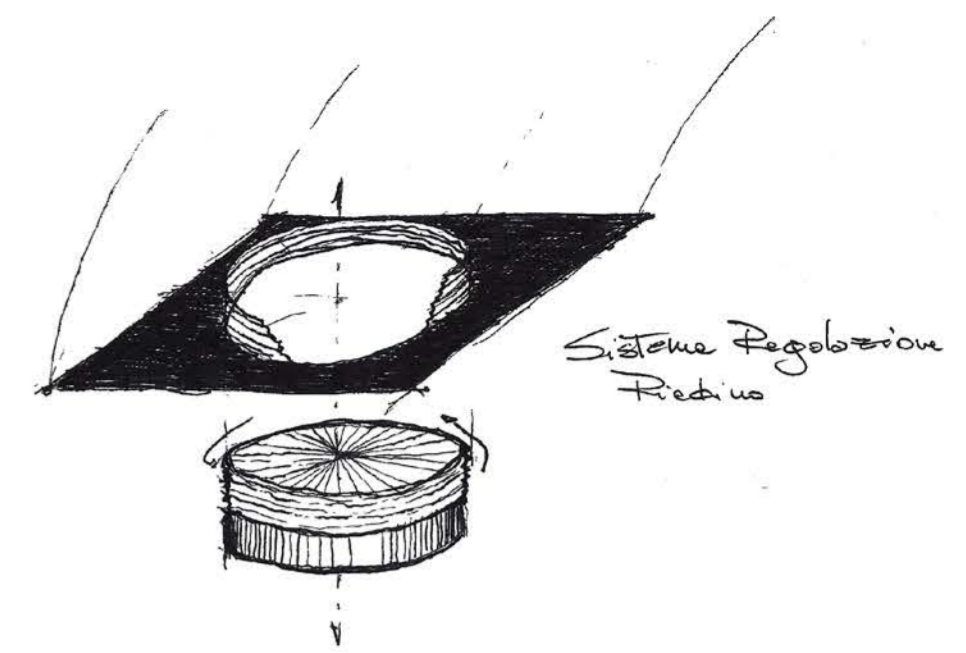

Sezione A-A - Section A-A
SCALA 1:20

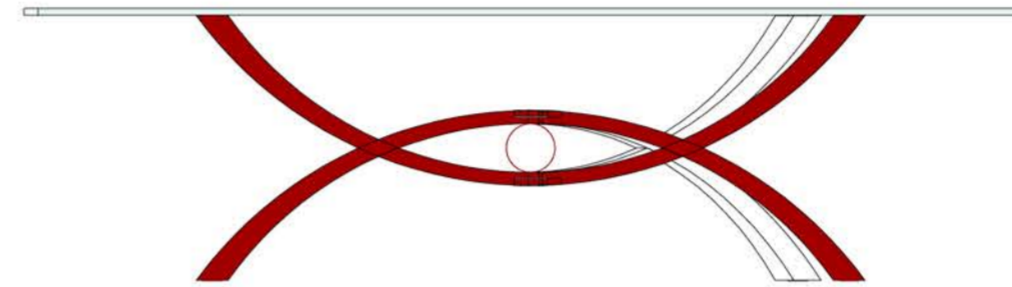

Sezione C-C - Section C-C
SCALA 1:20

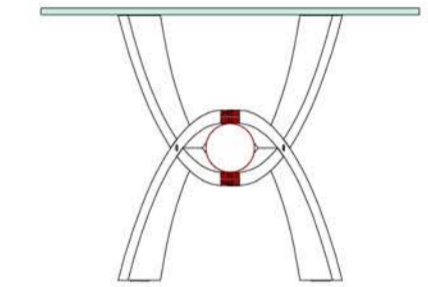

Sezione B-B - Section B-B
SCALA 1:20

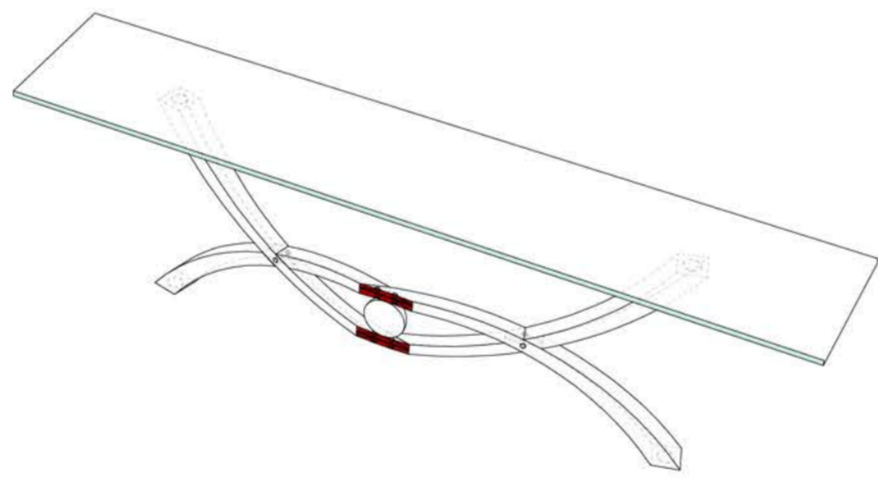

Esploso assometrico montaggio piastra
Exploded axonometric view plate mounting
SCALA 1:20

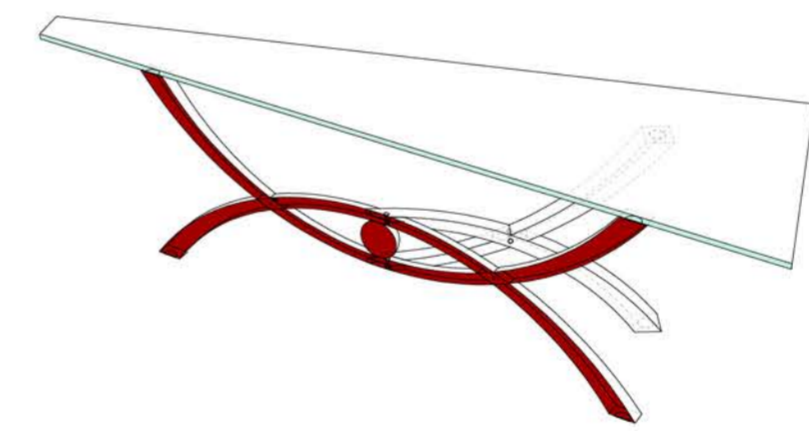

Esploso nodo centrale
Exploded axonometric view central node
SCALA 1:10

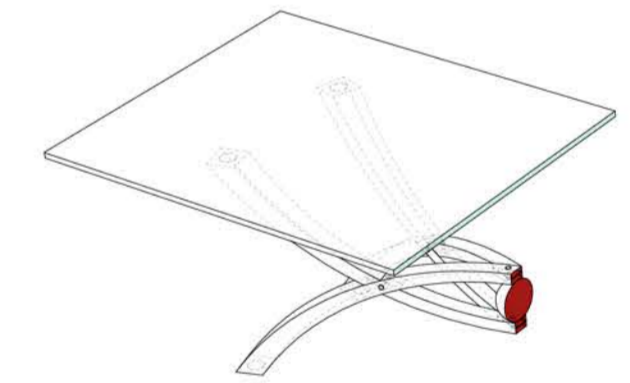

Esploso nodo esterno
Exploded axonometric view external node
SCALA 1:10

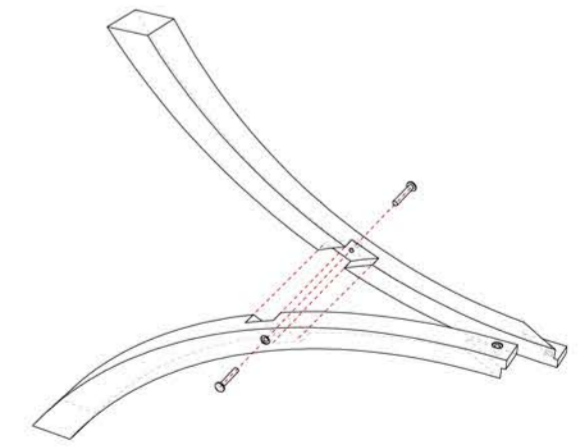
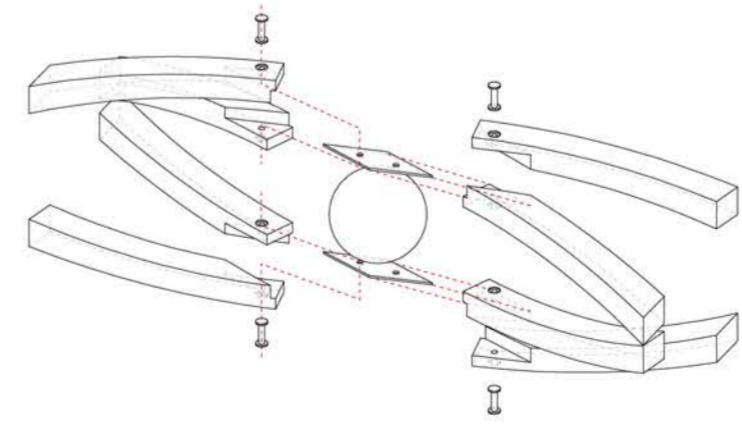
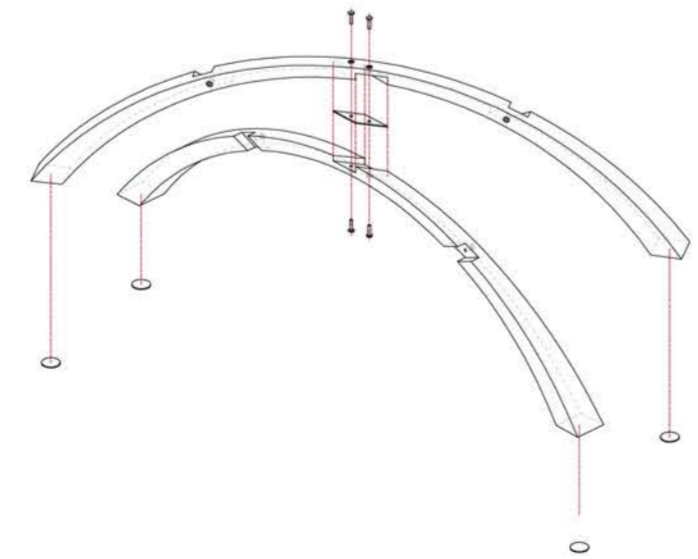



Rappresentazione Render
Render representation



Foto Modello scala 1:10
Model Photo, scale 1:10



Foto Modello scala 1:10
Model Photo, scale 1:10



Rappresentazione Render dettaglio
Render detail representation

porada INTERNATIONAL DESIGN AWARD 2013

POLI.DESIGN
Centro di Ricerca
del Politecnico
di Milano
ADI ASSOCIAZIONE
PER IL DISEGNO
INDUSTRIALE

Codice/Code:

P 4 0 1 6 0 4

AL-LA' - Dining table

Descrizione tavola:
Rappresentazione dell'oggetto, rendering foto del modello

TAV.
03